

INSTALLATION GUIDE

•

OWNER'S GUIDE

ALARM AND REMOTE STARTER • MODEL RS602E

CONTENTS

System Features	1
System Components	1
Tools Required	1
Technical Assistance	2
Before You Begin	2
Precautions	2
Testing Your Wires	2
Making Connections	3-4
Locating & Making Connections	4-6
Neutral Safety Switch	6
Antenna Placement	6
Factory Anti-Theft System	7
Connecting The 18-Pin Harness & 4-Relay Harness	7
Optional Connections	8-9
Testing Door Locks	9
Connecting Door Locks	10
Operating Instructions	10-11
Programming Instructions	11-12



Technical Assistance

All tech personnel are expertly qualified to answer any technical questions.

Technicians are available Monday through Friday from 9:00 a.m. until 8:00 p.m. and Saturday 10:00 a.m. until 4:00 p.m.

Address

288 Canton Avenue • Wintersville, Ohio 43953

Telephone

Phone: 740-264-4710 • 800-878-8007 • Fax: 740-264-7306

SYSTEM FEATURES

2 Four-Button Extended Range Remote Control	Remotely start your car to run the heater or air conditioning from an extended distance.
Keyless Entry	Remotely locks and unlocks your power door locks.
Built In Alarm Features	Provides door and hood protection.
Door Trigger Protection	Provides protection when doors are opened
Shock Sensor Input	A provided input for an external impact sensor.
Ignition Controlled Door Locks	A programmable feature that locks and unlocks the doors when the brake is depressed or the ignition is cycled.
Trunk Release	Remotely opens your trunk with a push of a button.
Extended Range Antenna	Allows you to operate your system from up to 800 feet away.
Low Voltage Start	Automatically starts your vehicle when battery voltage drops below 11 volts.
Automatic Hot and Cold Start	Remotely program your car to start at a preset temperature. Automatically starts your car in extreme temperatures.
Automatic Start	Remotely program your car to start every 3 hours regardless of temperature.
Dome Light Supervision	Never walk up to a dark vehicle again. When unlocking the vehicle by remote control the dome light will come on and stay on for 1 minute, or until you activates the ignition switch.
Remote Programmable Run Time	Remotely program your vehicle to run 5 to 25 minutes.
Parking Light Confirmation	Confirms that your vehicle has received a remote signal and will remain on if the engine is remotely started.
Horn and Siren Output	Lets you choose between the vehicle's factory horn or an optional six tone siren.
Remote Car Finder	Lets you locate you vehicle in a crowded parking lot.
Remote Valet	Lets you program off the alarm section when it is not needed.
Tach/Tachless Option	A programmable feature that lets you choose from the easy to install tachless operation or the standard wire-in, tach operation.
Pit Stop Mode	Allows you to exit the vehicle while the engine remains running.
Code Learning	Allows your remote starter to learn new remotes, should you want to add remotes, or if remotes are lost.
Starter Immobilizer	When the alarm is armed, this option breaks the starter wire in half so the vehicle cannot be hotwired.
Limited Lifetime Warranty	Guarantees life-long protection.

SYSTEM COMPONENTS

Your system includes:

- 1-Installation & Operation Guide
- 1-Main Control Module
- 2-Four Button Remote Transmitters with Slide Protectors
- 1- (4) Relay Harness with Relays
- 1- 18-Pin Wire Harness
- 1-Extended Range Antenna

- 2-Window Clips for Extended Range Antenna
- 1-Hood Pin Switch
- 1-Warranty
- 1-Warning Sticker for Under the Hood
- 2-Bulldog Window Decals

REQUIRED TOOLS

A 5/16 inch drill bit is needed when mounting the hood pin switch. You will also need a sharp knife, electrical tape and a computer-friendly test light. If the bottom of your dash on the driver's side will come off, you must remove it. If this is the case a screwdriver or a socket set may be needed,

TECHNICAL ASSISTANCE

Should you need help. First check our website at www.bulldogsecurity.com/wires.htm or call our toll-free Tech Support Hotline Monday through Friday 9AM-8PM and Saturday 10AM-4PM EST at 800-878-8007.

You must give the following information:

- Name
- Telephone Number with Area Code (Fax number if applicable)
- Year, Make, and Model of the vehicle
- The model number of the system you are installing
- The type of assistance you are requesting

If you give the above information you will be called back as soon as possible, usually within 10 minutes.

BEFORE YOU BEGIN

Congratulations, you have purchased one of the most advanced remote starter systems ever made. Your new remote starter is a technological breakthrough utilizing the most advanced, state of the art technology and components. It is computer controlled and manufactured in the U.S.A. The dependability and variety of features make Bulldog Security the leader in the industry. Enjoy your new remote starter for years to come!

This remote system is designed to start your vehicle by sending a command signal from the remote transmitter or by programming automatic temperature or timed start. It is required that your installation is done in a well-ventilated area. **It is the responsibility of the owner to ensure that the remote system is not used to start the vehicle in an undesired location.**

It is recommended that a carbon monoxide detector be installed in the living area near a location where the vehicle may be garaged.

Since there are many different makes and models of vehicles, look at the wiring chart on or our website, www.bulldogsecurity.com/wires.htm.

Read this manual thoroughly before starting the installation. You must also decide if any options are desired such as trunk release and dome light supervision. An optional relay will be needed for these options. **Please do not skip any steps.**

TACH/TACHLESS OPERATION

In most cases the decision to go with tachless mode will save time during the installation. If your vehicle is hard-starting then you should use tach mode.

MAKE SURE YOU PLACE THE WARNING STICKER UNDER THE HOOD.

PRECAUTIONS

This system is designed for vehicles with power door locks only. This system is designed to be used with fuel-injected, automatic transmission vehicles only.

SAFETY FIRST!

Never start your vehicle if it is indoors, if the keys are in the ignition and you're sure the car is in park. A periodic safety check is recommended to ensure that your system is in proper working order.

DO NOT use mechanical wiring connections, such as **crimp or snap together taps**. Follow instructions below.

DO NOT disconnect the battery if the vehicle has an anti-theft-coded radio or is equipped with an airbag. Doing so may cause a warning light to be displayed and may require a trip to the dealer to be corrected.

DO NOT leave the interior or exterior lights on for an extended period of time as it may cause battery drain. Remove the dome light fuse from the fuse box. **NOTE:** Starter systems do not work well with a partially discharged battery.

DO NOT mount the control module until all connections have been made and tested. Using wire ties or double sided tape, **MOUNT THE MODULE UNDER THE DASH**. Place the warning sticker under the hood.

WARNING!

GENERAL MOTORS REAR WHEEL DRIVE VEHICLES AND DODGE DAKOTAS

All General Motors rear wheel drive vehicles and Dodge Dakotas built prior to 1996 do not have an electrical Neutral Safety switch. They have a mechanical neutral safety switch. The mechanical neutral safety switch operates as follows.

- a) The key will only turn to start position when the gear selector is in park or neutral.
- b) The key can only be removed from the ignition switch when the gear selector is in the park position.

You must use special precautions with this system.

TESTING YOUR WIRES

When testing for a positive or negative voltage, you must use a computer friendly test light (logic probe) or a volt/ohm meter. Make sure to probe and test each wire before making your connections.

MAKING WIRING CONNECTIONS

1. Strip back two inches of insulation on the wire from the keyless entry.



2. Strip back one inch of insulation on the wire you need to connect to.

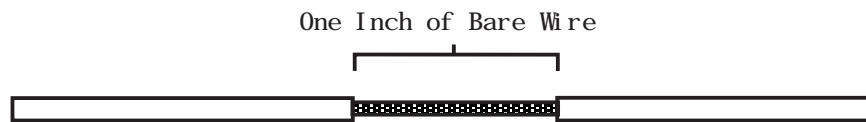

3. Separate the vehicle wire as shown. Make the separation large enough to fit the other wire through.



4. Insert the wire from the unit through the hole as shown.

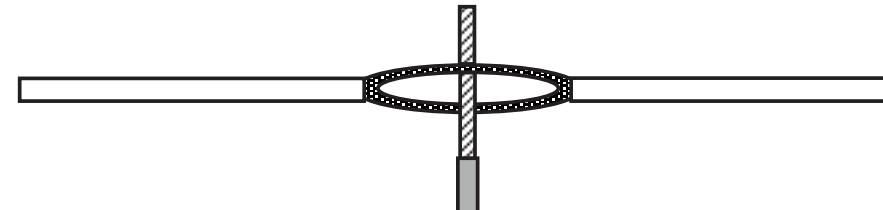

5. Wrap the wire around one side then the other and finally around itself as shown.

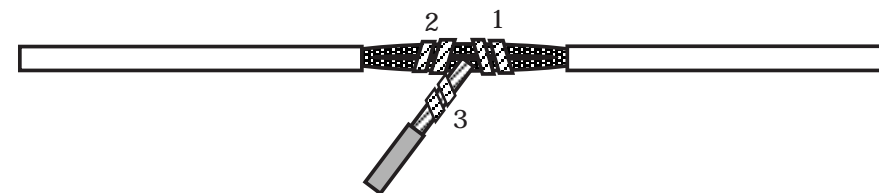

6. Use electrical tape to wrap. Be sure to cover the wire about two inches on either side of the connection. First pull the wire that you have just connected along side the wire you connected to, tape and wire tie them together. Use this method for all connections.



CAUTION: All wires must be wrapped and taped.

MAKING END TO END CONNECTIONS FOLLOW THESE INSTRUCTIONS

1. When tying two separate wires together at their ends, strip back 1" of insulation on both wires and separate the strands of wire as shown below.

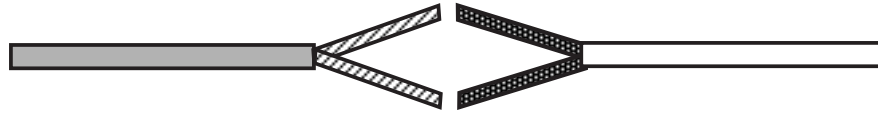

2. Twist upper wires together, twist lower wires together as shown.

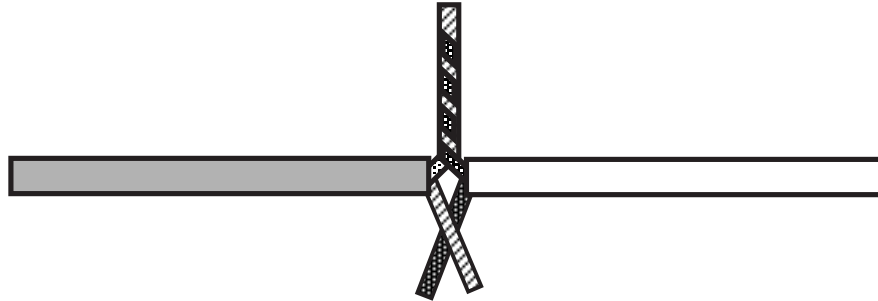

3. Lay upper twisted pair of wires over right wire as shown. Bring lower twisted pair of wires up to meet the left wire as shown.

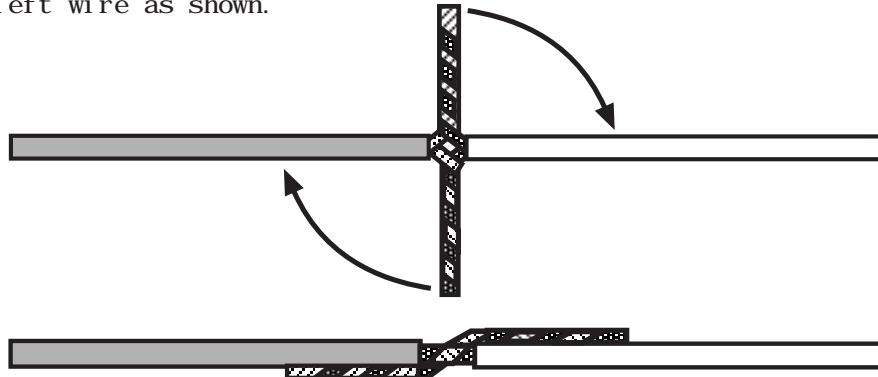

4. Use electrical tape to wrap, be sure to cover about 2 inches on either side of connection. Secure with wire ties as shown.

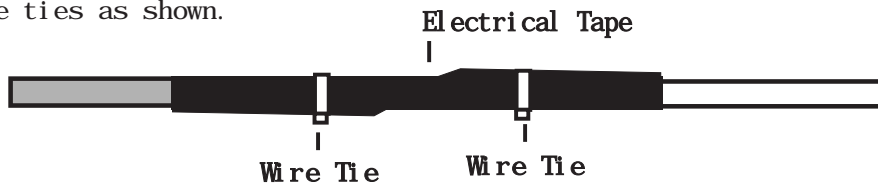

Use this method **ONLY** when connecting two separate wires end to end.

LOCATING & MAKING CONNECTIONS

Please see the wiring chart on our website, www.bulldogsecurity.com.

CONSTANT POWER (+12V, key in any position including off)

These wire(s) are in your vehicle's main ignition harness, usually located on the steering column coming from the ignition switch. Probe each wire with your test light. The correct wire(s) will show +12V when the ignition switch is in these 5 positions (ACC-LOCK-OFF-RUN-CRANK).

1. If your vehicle has only (1) constant power wire, attach the **RED** wire from the 18-pin harness and both large **RED** wires from the 4-relay harness to the constant power wire in the vehicle.
2. If your vehicle has (2) constant power wires, attach the **RED** wire from the 18-pin harness and (1) large **RED** wire from the 4-relay harness to one of these constant power wires. Then connect the other large **RED** wire from the 4-relay harness to the second constant power wire in the vehicle.

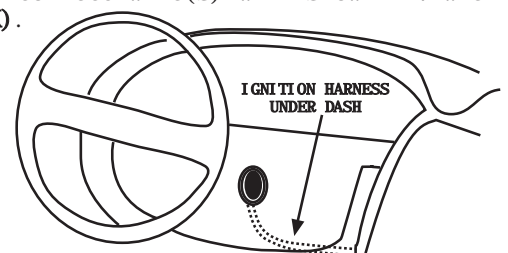

Make sure to wrap electrical tape around all (3) fuse holders to prevent shorting to ground.

IGNITION WIRE(S) (+12V in run and crank position only)

The ignition wire(s) are also located in the main harness coming from the ignition switch. Probe each wire with your test light, the correct wire(s) will show +12V **only** when the ignition switch is in the **RUN AND CRANK** positions only. The correct wires will not show +12V when in the OFF or ACCESSORY position. Most Ford, GM, and Chrysler vehicles have at least (2) ignition wires. Most foreign vehicles have only (1).

1. Strip back the **YELLOW** wire from the 18-pin harness and then strip back (1) of the (2) **WHITE** wires from the 4-relay harness and twist both of these wires together.
2. Connect the **YELLOW** wire and the **WHITE** wire from step (1) to the ignition wire in the main harness. If your vehicle has only (1) ignition wire, tape off the end of the second **WHITE** wire from the 4-relay harness and do not use.
3. If your vehicle has (2) ignition wires, connect the second **WHITE** wire from the 4-relay harness to it.
4. If your vehicle has (3) ignition wires (some GMS) connect the second **WHITE** wire from the 4-relay harness to both the second and third ignition wires in the vehicle.

ACCESSORY WIRE(S) THAT POWER THE HEATER/BLOWER MOTOR

(+12V in run or on positions) This wire is also in the main ignition switch harness usually located in the steering column. Make all connections as close to the ignition switch harness as possible.

Most vehicles will have (1) accessory wire; however **some** Fords, newer GM vehicles and Chrysler 94 and up will have (2) or more accessory wires. To locate these wire(s) probe for wire(s) that only show +12V when the ignition switch is in the **RUN** or **ON** positions. This wire(s) will not show +12V when the ignition switch is in any other position.

1. If your vehicle has only (1) accessory wire connect the **WHITE WITH BLACK STRIPE** wire from the 4-relay harness to this wire.
2. If your vehicle has (2) accessory wires, connect the **WHITE WITH BLACK STRIPE** wire to both.
3. If your vehicle has (3) accessory wires connect the unused **WHITE** wire from the 4-relay harness to the third accessory wire.

STARTER/CRANK WIRE (+12V only in the start position only)

The starter/crank wire is also in the main harness. Locate the wire that shows +12V **only** in the **crank** position. This wire will not show +12V in any other position. Attach the **YELLOW WITH BLACK STRIPE** wire from the 4-relay harness to this wire.

CHASSIS GROUND

Locate an easy to get to bolt or screw located under the driver's side of the dash and attach the **BLACK** ground wire from the 18-pin harness securely as pictured.

Factory Bolt



Black Ground Wire

Note: Remove any paint below the spade connector.

PARKING LIGHTS (+12V only with parking lights on)

Turn the parking lights to the ON position. (NOT YOUR HEADLAMPS). Probe the wire(s) coming from your headlamp control switch. Find a wire that will show +12V only when the parking lights are ON. Connect the **BROWN** wire from the 18-pin harness to this wire. If this wire tests as a (-) negative, see diagram.

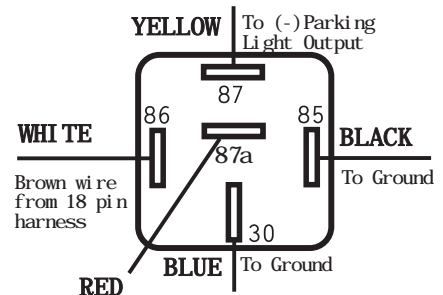

NEGATIVE PARKING LIGHT OUTPUT
Optional part #775 required.

DO NOT USE THE RED WIRE, TAPE OFF.

BRAKE INPUT

The brake wire is located on the switch near and above the brake pedal. The correct wire will show +12V only when the brake is pressed. Connect the **BLUE WITH BLACK STRIPE** from the 18-pin harness to this wire.

FACTORY ALARM SHUT DOWN WIRE (FASD) (-)

If your vehicle is equipped with a factory alarm system (as most vehicles with a factory keyless entry are) probe for a small gauge wire (usually found in the driver's side kick panel) that shows (-) ground when the door lock cylinder is turned to the unlock position using the key. This wire will usually show a (+) positive voltage before turning the key. **NOTE:** Some factory disarm wires remain neutral before you turn the key to unlock instead of +12v positive. Connect the **RED WITH BLACK STRIPE** wire from the 18-pin harness to this wire.

HOOD PIN SWITCH

This feature will keep the engine from starting or shut off the engine when the hood is opened. Locate a good chassis ground, if at all possible do not install the pin switch in the rain gutter. Drill a 5/16 hole, insert the pin switch into the hole and tighten. Check for the hood adjustment, there is approximately 1/4" adjustment in the pin switch. Close the hood easy, making sure that the pin switch is not keeping the hood from closing all the way, if it does, cut off approximately 1/8" of the black plastic off of the top of the hoodpin switch and try closing the hood again. Check to make sure that the hoodpin switch remains neutral when the hood is closed and shows ground when the hood is open. Plug the **BLACK WITH BLUE STRIPE** wire from the 18-pin harness into the bottom of the hood pin switch.

TACH INPUT (Optional)

By this time, you should have determined the way you want your vehicle to start (tach or tachless). If you have chosen the TACHLESS start option, simply proceed to the next step and skip the following connection instructions. Make sure to tape the **BLACK WITH WHITE STRIPE** wire up if not used. For TACH mode connect the **BLACK WITH WHITE STRIPE** wire from the 18-pin harness to the negative side of the coil or the tach wire at the coil pack under the hood. To find the coil pack follow the spark plug wires back to the termination point. To operate in tach mode, make sure to program tach option, see programming tach option page 11.

NEUTRAL SAFETY SWITCH

PRE-1996 GM REAR WHEEL DRIVES WITH PURPLE CRANK WIRE Optional part #775 required.

MECHANICAL NEUTRAL SAFETY SWITCH (Rear Wheel Drive Only)

When installing a Bulldog remote starter on GM vehicles or Dodge Dakotas built prior to 1996, you must:

Use the diagram below to create a circuit that will prevent the remote starter from starting the vehicle unless the key is removed from the ignition switch.

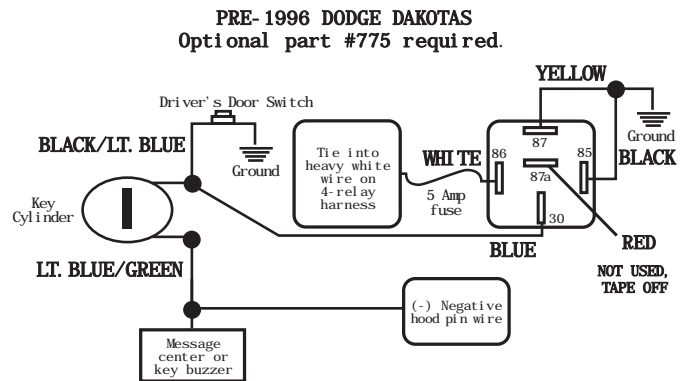
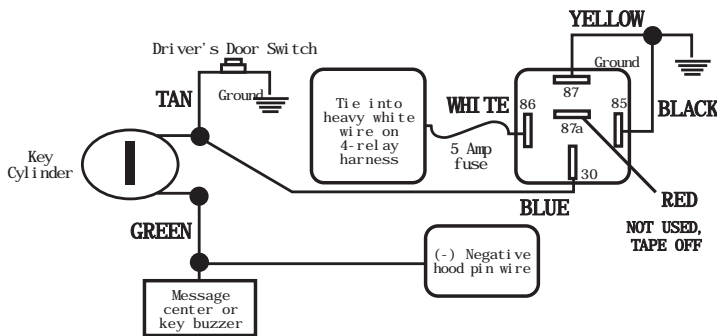

ANTENNA PLACEMENT

E MODEL REMOTE STARTERS

Run the antenna up the windshield pillar on the driver's side and across the top of the windshield to the center, behind the rearview mirror. Use the antenna clips provided to hold it in place. Be sure to expose the full length of the clear antenna. It will perform best if mounted vertically, below the dark windshield tint. **Never leave antenna in headliner.** Range is up to 800 feet. Each receiver is tested to more than 400 feet (800 feet, E models) of clear air

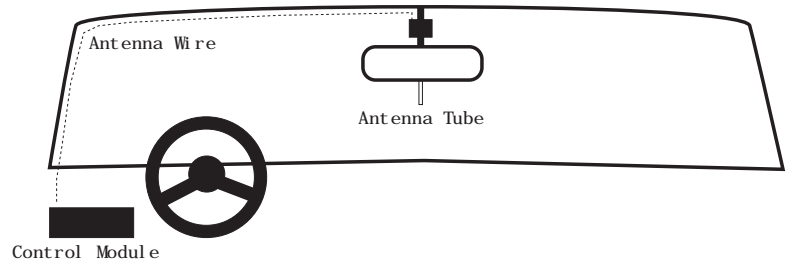

reception. While many times you will see a higher range. Many factors will affect the range, including the amount of radio signals in the area, battery strength, window tint, etc.

FACTORY ANTI - THEFT SYSTEMS

FOR GENERAL MOTORS CARS ONLY

System 1: PASSKEY I and II system (1985 and up). This system has a resistor pill in the key. Measure resistance of the pill using a test meter. A bypass module is available, part #VATS-WR module.

System 2: PASSLOCK I and II system (1995 and up). Passlock does not have a pill in the key. It has a light on the dash that states **ANTI-THEFT OR SECURITY** system. A bypass module is available, part #GMBP-721 module.

System 3: PASSKEY III system (GM 1998 and up). Passkey III is GM's version of a transponder system. This key will have the letters PK3 on it. A bypass module is available. (Part #781)

FORD ANTI-THEFT SYSTEM: PATS

Ford uses a bypass part #FBP-718 module, 1995-1998. (1999 and up will use part #781.)

CHRYSLER AND MOST IMPORTS ANTI-THEFT SYSTEM: TRANSPONDER

1998 and up will use part #781.

To order these bypass modules call 1-800-878-8007.

CONNECTING THE 18-PIN HARNESS & 4-RELAY HARNESS

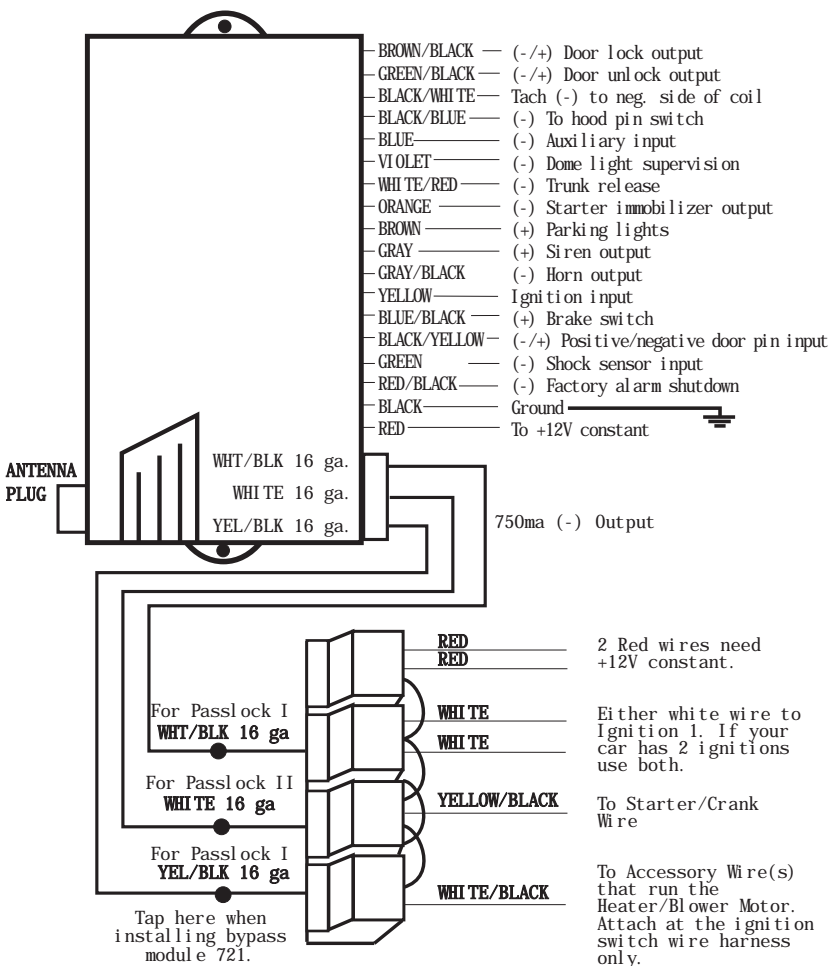

CAUTION: Before connecting the 18-pin harness to the module, double check all connections to be sure they are secure and properly wrapped with electrical tape. Make sure you mount the unit under the driver's side dash and secure the unit in place with 2 wire ties. Make sure to properly place the antenna, see antenna placement, page 6. Next, plug the RED antenna plug into the main control module. Make sure you plug the 18-pin harness and the 3-pin from the 4-relay harness into the main module.

Press the start button, the parking lights will flash once and the vehicle should start and run. If your vehicle does not start and run you may have a factory anti-theft system. Refer to pages 7 to see if this applies to your vehicle. If the vehicle does start and run and you wish at this time to install your door locks, proceed to page 10.

OPTIONAL CONNECTIONS

DOOR PIN TRIGGER

To determine if your door pin is turned on with (+) positive or (-) negative trigger, probe for a wire in the driver's side kick panel that switches polarity when the door is closed then opened. You can also find this wire going to the under dash courtesy lights.

- If this wire reads +12V when the door is open and (-) ground when the door is closed, it is (+) positive. (most Fords)
- If this wire reads (-) ground when the door is open and +12V when the door is closed, it is (-) negative.

If your vehicle is a (+) positive door pin connect the **BLACK WITH WITH YELLOW STRIPE** wire from the 18-pin harness to the door pin wire. **Follow the instructions on page 11** to program your unit to work with a (+) positive door pin. If your vehicle is a (-) negative door pin, connect the **BLACK WITH WITH YELLOW STRIPE** wire from the 18-pin harness to the door pin wire. **Follow the instructions on page 11** to program your unit to work with a (-) negative door pin.

NOTE: When testing the door pin wire, make sure the dome light is on. Some vehicles, if the door is left open for a period of time, the dome light will go out, resulting in a false reading.

DOME LIGHT (Optional Part #775 required)

Once you have determined if your door pin wire is a (+) positive or (-) negative and you have made this connection, next, you must decide if you are going to connect the dome light supervision function which will require an optional relay. This relay will also need to be connected in a (+) positive or (-) negative configuration depending on the type of door pin in your vehicle.

SHOCK SENSOR INPUT

The GREEN WIRE on the 18-pin harness is a negative input to be used when installing an external shock sensor, motion sensor or trunk pin. If this wire is not used, make sure to tape it up.

(-) Negative Dome Light Type (All other vehicles)

Connect the **VIOLET** wire from the 18-pin harness to the **WHITE** wire on the optional #775 relay harness. Connect the **BLACK** wire on the optional relay to +12V constant fused at 5 amps. Connect the **BLUE** wire to ground. Connect the **YELLOW** wire to the dome light circuit.

DOME LIGHT SUPERVISION
Optional part #775 required.

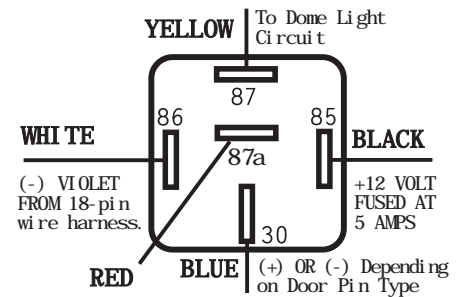

DO NOT USE THE RED WIRE, TAPE OFF.

TRUNK RELEASE OUTPUT (Optional Part #775 required)

Locate the trunk release wire coming from the back of the trunk release switch. To determine if your trunk release is tripped by a (+) positive or a (-) negative (most trunk release switches are (+) positive). Place one end of your test light to ground, press the "Trunk" button, if the test light illuminates, you have a (+) positive trunk release. If it does not, connect the test light to +12V constant and probe the wire. If the test light illuminates when the button is pressed, then you have a (-) negative trunk release.

Connect the **WHITE WITH RED STRIPE** wire to the **WHITE** wire of the optional relay. Please see diagrams below for correct connections.

NEGATIVE TRUNK RELEASE

POSITIVE TRUNK RELEASE

Optional part #775 required.

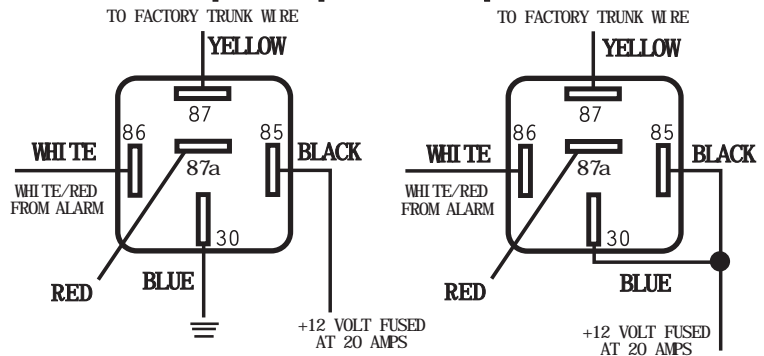

THE RED WIRE IS NOT USED, TAPE OFF.

SIREN OUTPUT (+) (Optional part #724)

Connect the **GRAY** wire from the 18-pin harness to the **RED (+)** positive input on the siren. Make sure you ground the **BLACK** wire on the siren.

HORN HONK OUTPUT (-)

(Optional part #775)

The existing horn wire will usually be found in the main ignition switch harness in the steering column. Probe for a wire which will remain neutral (in some cases may show a (+) positive). When the horn is pressed this wire will test as a ground or (-) negative. An optional, part #775 will be needed to do this function. Connect the **GRAY WITH BLACK STRIPE** wire from the 18-pin harness to the **WHITE** wire on the optional part #775. Connect the **BLACK** wire to (+)12V constant fused at 10 amps. Connect the **BLUE** wire to ground, connect the **YELLOW** to the horn circuit at the steering column.

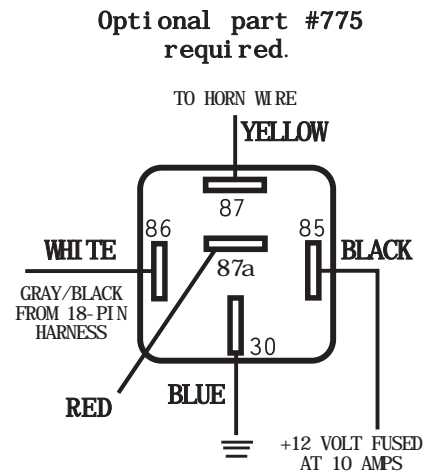

THE RED WIRE IS NOT USED,
TAPE OFF.

INSTALLING STARTER IMMOBILIZER (-) Output (Optional part #773)

Locate the same starter/crank wire located in the main wiring harness that you have tied the **YELLOW WITH BLACK STRIPE** wire from the 4-relay harness into. Cut the starter/crank wire in half, making sure that the **YELLOW WITH BLACK STRIPE** wire from the relay harness stays on the "starter side" and not the "switch side" of your starter immobilizer circuit. Connect the **RED** wire from the starter immobilizer to the "switch side" of the starter/crank wire then connect the **WHITE** wire to the "starter side" of the starter/crank wire. Connect the **ORANGE** wire from the starter immobilizer to the **ORANGE** wire on the 18-pin harness. **NOTE: You will need to cut factory wiring to make an end to end connection, see "Making Connections" on pages 3-4.**

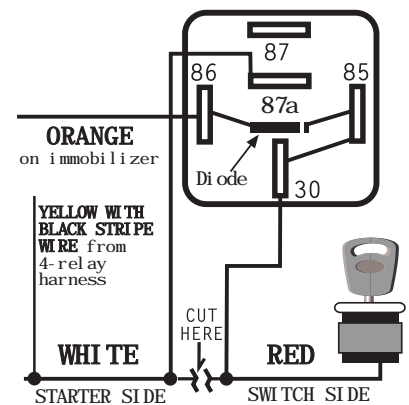

TESTING DOOR LOCKS

TESTING: Door Locks (OPTIONAL)

There are three basic types:

"Type A" Door Lock Test (Most GMs and most Chryslers)

Probe both of your door lock wires going to the door lock switch usually located in the driver's kick panel, attach the clip end of your test light to a good chassis ground. Using the vehicle's door lock controls, activate the lock then the unlock, testing both wires one at a time. If one of these wires tests (+) positive when lock is pressed and the other tests (+) positive when they are unlocked, your vehicle has a "Type A" door locking system. Make sure to mark which wire is lock and unlock. Proceed to connecting Door Locks. **NOTE:** "Type A" and "Type C" locks will test the same, until you test for ground. Make sure you run both tests before making your connections.

"Type B" Door Lock Test (Most Imports, some newer Fords)

Probe both of your door lock wires going to the door lock switch usually located in the driver's kick panel, attach the clip end of your test light to +12V. Using the vehicle's door lock controls, activate the lock then the unlock testing both wires one at a time. If the test light illuminates when you probe the lock and the unlock wires your vehicle has a "Type B" door locking system. Make sure to mark which wire is lock and unlock. Proceed to Connecting Door Locks.

"Type C" Door Lock Test (Most Fords, some Chryslers, GM Trucks)

Using your test light probe both the lock and the unlock wires usually located in the driver's kick panel. Attach the clip end of your test light to ground probing both wires one at a time while locking and unlocking the doors with the driver's side switch (usually the master switch). The test light should illuminate in both switch positions. Now attach the clip end of your test light to +12V constant, probe both wires one at a time again. The light should then illuminate again only in reverse order. This tells you that you have a "Type C" reversing polarity system. Make sure to mark which wire is lock and unlock.

Testing Switch Wire and Motor Wires

Before connecting, you must now determine which wire is the switch wire and which is the motor wire. Cut both the lock and unlock wires in half. Start with both of the lock wires by placing the clip end of your test light to ground, hold the door lock switch in the lock position, make sure you are using the master switch (usually on the driver's door) and probe both lock wires looking for voltage. The wire that illuminates the test light, mark as the switch wire, the wire that shows no voltage, mark as the motor wire. Repeat the procedure for the unlock wire. When connecting the lock and unlock wires to the #778 relay harness, make sure you connect the switch wire to the **RED** wire or pin #87A and the motor wire to the **BLUE** wire or pin #30. Be sure to connect the lock wires to the lock relay, and the unlock wires to the unlock relay, you may need to mark these relays before you start.

CONNECTING DOOR LOCKS (Optional)

CONNECTING "TYPE A LOCKS"

• If your vehicle has a "Type A" door locking system, connect the **BROWN WITH BLACK STRIPE** wire from the 18-pin harness to the door lock wire. Connect the **GREEN WITH BLACK STRIPE** wire to the unlock wire. See diagram below.

"Type A" - Positive type door locks used on most GM, some Chrysler vehicles.

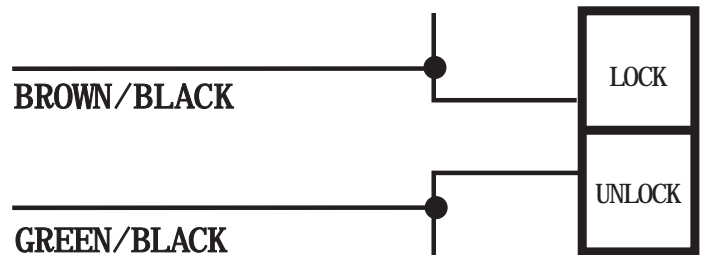

CONNECTING "TYPE B LOCKS"

• If your vehicle has a "Type B" door locking system, connect the **GREEN WITH BLACK STRIPE** wire from the 18-pin harness to the door lock wire. Connect the **BROWN WITH BLACK STRIPE** wire to the unlock wire. See diagram below.

"Type B" - Negative type door locks used on most imported vehicles and some newer Fords.

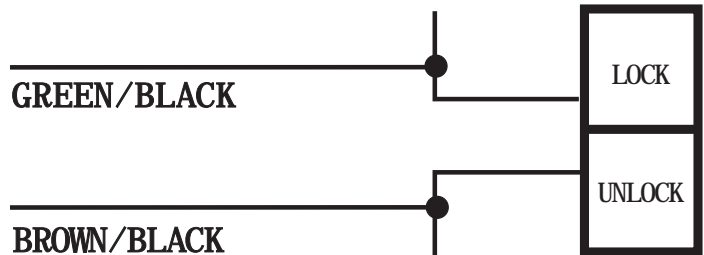

CONNECTING "TYPE C LOCKS"

• If your vehicle has a "Type C" door locking system, you will need to purchase optional part #778. Once you have purchased the relays, follow the diagram on page 18 for "Type C" door locks.

TYPE C - (Optional Part #778 required)

Reverse polarity door locks. Used on most GM trucks, Ford and Chrysler vehicles.

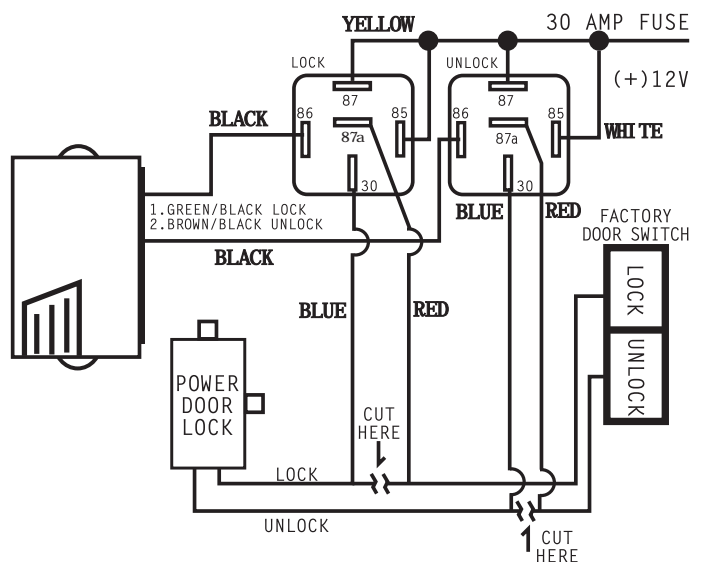

OPERATOR PROGRAMMING INSTRUCTIONS

WE RECOMMEND THAT YOU USE FACTORY SETTINGS FIRST

ENTERING PROGRAMMING MODE

Make sure your vehicle is not running and the brake is pressed. The brake is to remain pressed as long as you want to remain in programming mode. The unit will exit the programming mode simply by releasing the brake. The parking lights will flash three (3) times confirming that you are out of programming mode.

INSTALLATION PROGRAMMING:

Programming Tach/Tachless Start

Press and hold the brake, then press and hold Button #3 (trunk) until the parking lights flash three (3) times. Release Button #3. Press and release Button #4, the parking lights will flash once. The unit is now in Tachless Start Mode. Press and release Button #4, the parking lights will flash twice. The unit is now in Tach Start Mode. Release the brake, the parking lights will flash three (3) times. The programming is now entered. **NOTE:** Factory setting is Tachless Start Mode.

Programming Door Lock Pulse Length

Press and hold the brake, then press and hold Button #3 (trunk) until the parking lights flash three (3) times. Release Button #3. Press and release Button #1, the parking lights will flash once, the door lock pulse length is now 3.5 seconds. Press and release Button #1, the parking lights will flash twice, the door lock pulse length is now .7 seconds. Release the brake, the parking lights will flash three (3) times. The programming is now entered. **NOTE:** Factory Door Lock Pulse Setting is .7 seconds.

Programming Double Pulse Unlock Output (Factory Security Shutdown)

Press and hold the brake, then press and hold Button #4 (stop) until the parking lights flash four (4) times. Release Button #4. Press and release Button #3, the parking lights will flash once. Double Pulse Unlock is on. Press and release Button #3, the parking lights will flash twice. Double Pulse Unlock is now programmed off. Release the brake, the parking lights will flash three (3) times. The programming is now entered. **NOTE:** Factory Setting is Double Pulse off.

Programming Doorpin Inputs

Press and hold the brake, then press and hold Button #4, the parking lights will flash (4) times, release. Now press and release Button #1. The parking lights will flash once, the unit is now programmed for a (+) positive doorpin. Press and release Button #1 again, the parking lights will flash twice, the unit is now programmed for a (-) negative doorpin.

OPERATOR PROGRAMMING:

Adding New Transmitters

Press and hold the brake, then press and hold Button #1 (start) until the parking lights flash once. Release Button #1. Press any button on the new remote, the parking lights will flash three (3) times, the new remote is now programmed.

Programming Lock with Brake, Unlock with Ignition Off

Press and hold the brake, then press and hold Button #3 (trunk) until the parking lights flash three (3) times. Release Button #3. Press and release Button #2, the parking lights will flash once. The unit will now lock with the brake and unlock when the ignition is turned off. Press and release Button #2 again, the parking lights will flash twice. The Lock with Brake feature is now turned off. Release the brake, the parking lights will flash three (3) times. The programming is now entered. **NOTE:** Factory setting is Lock with Brake off.

Programming Automatic Start Options

Press and hold the brake, then press and hold Button #2 (arm/disarm) until the parking lights flash twice. Release Button #2. Press and release Button #1, the parking lights will flash once. You are now in **3 hour Start Mode**. Your vehicle will start every three (3) hours. Press and release Button #1 a second time. The parking lights will flash twice for **Low Voltage Start**. To discontinue automatic start options, press and release Button #1 a third time. The parking lights will flash three (3) times, the **Automatic Start Option is now off**. Release the brake, the parking lights will flash three (3) times. The programming is now entered. **NOTE:** The factory setting is Automatic Start Option off.

Programming Cold Start

Press and hold the brake, then press and hold Button #2 (arm/disarm) until the parking lights flash twice. Release Button #2. Press and hold Button #2, the parking lights will flash once. Each continuous flash represents a progression in degrees: one (1) flash= -40°F, two (2) flashes=-30°F, three (3) flashes=-20°F, four (4) flashes=-10°F, five (5) flashes=0°F, six (6) flashes=10°F, seven (7) flashes=20°F. To disable Cold Start, press and hold Button #2 until the parking lights flash seven (7) times, then two (2) quick flashes 8 and 9. The Cold Start is now disabled. Release the brake, the parking lights will flash three (3) times, the programming is now entered. **NOTE:** The factory setting is Cold Start off.

Programming Hot Start

Press and hold the brake, then press and hold Button #2 (arm/disarm) until the parking lights flash twice. Release Button #2. Press and hold Button #3, the parking lights will flash once. Each continuous flash represents a progression in degrees: one (1) flash=160°F, two (2) flashes=150°F, three (3) flashes=140°F, four (4) flashes=130°F, five (5) flashes=120°F, six (6) flashes=110°F, seven (7) flashes=100°F. To disable Hot Start, press and hold Button #3 until the parking lights flash seven (7) times, then two (2) quick flashes 8 and 9. The Hot Start is now disabled. Release the brake, the parking lights will flash three (3) times, the programming is now entered. **NOTE:** The factory setting is Hot Start off.

NOTE: Only Cold and Hot Start functions can be enabled at the same time. If button #1 is pressed for programming, Cold/Hot Start is disabled. When Buttons #2 and #3 are pressed, then the Automatic and Low Voltage Starts are disabled.

SPECIAL PROGRAMMING MODE:

Valet Mode On

Press and hold the brake, turn Ignition Key to the Run position. Within five (5) seconds, press and release Button #4. The horn will sound or the siren will chirp once, the parking lights once. Valet is now on. Release the brake, turn the ignition key off.

Valet Mode Off

Press and hold the brake, turn Ignition Key to the Run position. Within five (5) seconds, press and release Button #4. The horn will sound or the siren will chirp twice, the parking lights twice. Valet is now off. Release the brake, turn the ignition key off.

Temporary Silent Arm/Disarm (This Arming Only)

Press and hold Button #2 for approximately two (2) seconds, the parking lights will flash once, the unit is now programmed for Silent Arming. Press and release Button #2, the parking lights will flash twice, and remain on for one (1) minute, the unit is now Disarmed.

Silent Arm/Disarm (Remains In Silent Mode Until Programmed Back On)

Press and hold Button #2 for approximately five (5) seconds, when arming, the parking lights will flash without the horn or siren sounding. Hold until the parking lights flash three (3) times, release. Silent arming/disarming is now programmed on. To program it back on, repeat these steps. After the parking lights flash again three (3) times, silent arming/disarming is programmed off.

Runtime Programming (Engine Off)

Press and hold Button #4 (stop) for approximately 10 seconds. The horn will honk twice, then the parking lights will begin to flash, each flash represents 5 minutes with the maximum being 25 minutes, 5 flashes. Simply release button at whatever runtime you desire. To check programmed runtime, press and release Button #4 (stop). The parking lights will flash for the amount of runtime you have programmed the unit for.

Clearing the E-Prom

Press and hold the brake, now cycle the key in the ignition switch from OFF to RUN (not start) five (5) times within four (4) seconds. If you cannot physically do this in the proper amount of time, then remove the **YELLOW** ignition input wire from Ignition I and touch this **YELLOW** wire to +12V constant five (5) times within four (4) seconds. Release the brake, now try the remote. The unit should not function. If it does repeat the above procedure. If the unit does not function, unplug the unit from both harnesses, wait one (1) minute and plug it back in. Press Button #4 (stop) the parking lights will flash three (3) times, the unit is now back to factory default and ready to operate.

HOW TO USE YOUR REMOTE TRANSMITTER

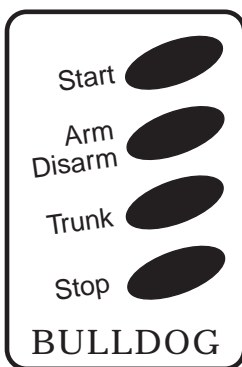

BUTTON #1
Remote starts your vehicle from up to a quarter mile away.

BUTTON #2
Arm locks and disarm unlocks your power door locks.

BUTTON #3
Pops your trunk.

BUTTON #4
Turns off your remote starter and helps you locate your car (when system is armed).

Starting the Vehicle with the Remote Transmitter
Press and release button #1 (start). The parking lights will flash once, confirming the car starter received the signal. The car will then start and the parking lights will turn on and remain on while the vehicle is running. To shut off the engine before the preset time, press button #4 (stop) or press the brake pedal or when the hood is opened. **NOTE:** If your car does not start on the first crank it will automatically attempt to start up to 2 more times. (only in tachless mode) In tachless mode, parking lights will wait approximately 10 seconds before turning on.

Pit Stop: Exiting the Car with the Engine Running

Make sure the transmission is in park and press button #1 (start) before turning the ignition switch off. (The engine will remain running for the preset time.)

Keyless Entry Operation

Press button #2 (lock/unlock), the parking lights will flash once and the doors will lock. Press button #2 again, the parking lights will flash twice, the doors will unlock, and the parking lights will remain on for one minute or until you turn the ignition on or press the brake.

Dome Light Supervision Option

The remote starter includes an optional output that can be used to illuminate the dome light when pressing button #2 and unlocking your power door locks. The dome light will remain on for one minute or until you turn the ignition on or press the brake.

Trunk Pop Output

The remote car starter includes an optional output that can be used to do one of the following: open the trunk (optional relay required), roll up the windows (optional module needed), close the sun roof (optional module needed) etc. This output will pulse .75 seconds when pressed and released. In instances where a continuous signal is needed such as sun roof and power windows, hold down Button #3 (trunk) as long as the signal is needed to complete the task. The parking lights will remain on as long as this button is being pressed.

Remote Car Finder (Armed Only)

When the unit is armed, press and release Button #4, the horn or siren will chirp three (3) times and the parking lights will flash three (3) times.

Runtime Confirmation (Disarmed Only)

With the engine off, press and release Button #4 (stop). The parking lights will begin to flash, each flash represents the programmed runtime. Example: 5 flashes = 25 minutes.